

Cob ist ein Kurvenglaser, der zur Beleuchtung des Kegels entwickelt wurde

Wände und geschwungene Fassaden sorgen für ein akzentuiertes Licht Wirkung mit seinem präzisen optischen Design und einstellbar Module. Das kleinere Pitch-Design bietet seitliche Biegungsfunktionen und die beiden Montageprofile sorgen für Cob-Passform verschiedene gekrümmte Oberflächen.



### Features

Color Temperature	2700K, 3000K, 3500k, 4000K, 5000K, 5700K, 6500K
Length of the Module	300mm, 600mm, 1200mm (7 Diodes per foot)
Optics	15°, 20°, 30°, 20°x40°, 20°x50°
Dimming	ON/OFF

### Mechanical Specifications

Housing Material	Polycarbonate
Connecting Body	Thermoplastic polyurethane (TPU)
Lens Material and Cover	Optical grade PMMA
Surface Color	Black

### Luminaire Performance

Color Consistency	3 SDCM
Color Rendering	CRI80
Lumen Maintenance	L70 50,000hrs @25°C
Lumen Efficiency	930 lm per foot @3000K CCT, CRI80, 15°

### Electrical Specifications

Voltage	DC 24V
Power Consumption	11.25W / foot

# PRODUCT SPECIFICATION

**COB Flex**

Flex Linear Static White

## System Specifications

The maximum number of connected modules (7 diodes per module) in a daisy chain:

Power/Module	Input voltage	Max. Lauflänge beinhaltet power feed to the end of the fixtures in the daisy chain	Max. Anzahl der Module fixtures can be clusted on a single contiguours run	Max. power allowable in a daisy chain
11.25W	24V	15 Meters	9 modules	108W

Remark: The above values and number are only typical values. Actual number may vary due to the cable lengths and signal source.

Die Adern im Strom- und Datenkabel sind gemäß der folgenden Tabelle gefärbt:

ON/OFF

Cable	Dimming	Function	Core(US)	Wire Size	Core(EU)	Wire Size
Power lead in/ Power extension Cable	ON/OFF	DC+	Red	18AWG	Brown	0.75mm <sup>2</sup>
		DC-	Black	18AWG	Blue	0.75mm <sup>2</sup>

## Umfeld

Storage Temperature	-30°C to 60°C
Operating Temperature	-20°C to 50°C
Ingress Protection Rating	IP66

**SLS**

Swiss Lighting Solution



# PRODUCT SPECIFICATION

**COB Flex**

Flex Linear Static White

## Anschlusszubehör (separat bestellen)

### Lead-In and Jumper Cables:

Product Image	Part Number	Length (mm)	Application	Cable End		Conductor Size	Region
	ECACF(DN)-300-2pin-EU	300	Power Lead 2000	Female	Bare Wire	2x0.75mm <sup>2</sup>	Europe
	ECACF(DN)-2000-2pin-EU	2000					
	ECACF(DN)-6000-2pin-EU	6000					
	ECACF(DN)-300-2pin-US	300					
	ECACF(DN)-2000-2pin-US	2000					
	ECACF(DN)-6000-2pin-US	6000					
	ECACL(DN)-003 -2pin-EU	300	Power Extension 600	Female	Male	2x0.75mm <sup>2</sup>	Europe
	ECACL(DN)-006 -2pin-EU	600					
	ECACL(DN)-018 -2pin-EU	1800					
	ECACL(DN)-003 -2pin-US	300					
	ECACL(DN)-006 -2pin-US	600					
	ECACL(DN)-018 -2pin-US	1800					

## Biegefestigkeit (obere Biegung)

**208.8 x 240 Durchmesser 240 Ø**

# PRODUCT SPECIFICATION

**COB Flex**

Flex Linear Static White

## Mounting Accessories - Tree Mount (order separately)

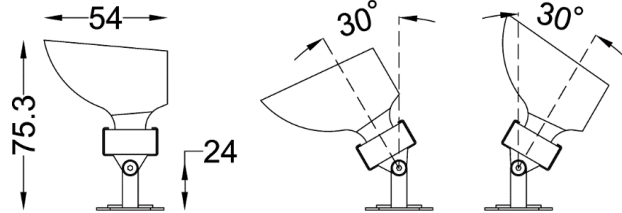
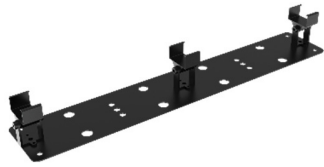

**Item:** LLL-TM-COB

**Description:** Flexible metal mounting adjustable clip for Cobra Flex Washer

### Top View:

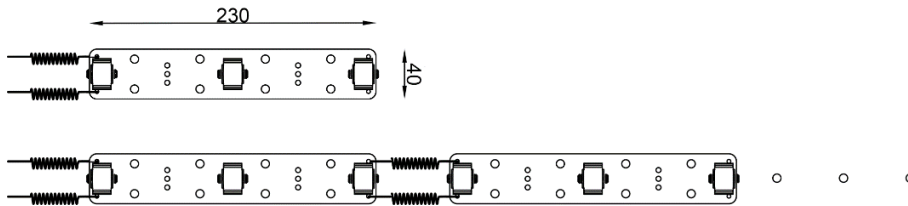

### 3D Views:

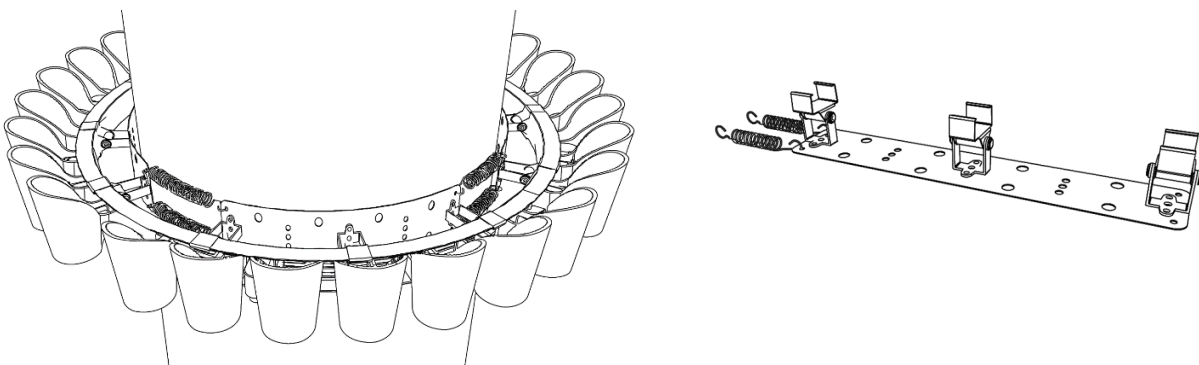

*\*Please refer to the installation manual for more details*

# PRODUCT SPECIFICATION

**COB Flex**

Flex Linear Static White

## Mounting Accessories – Wall Mount (order separately)

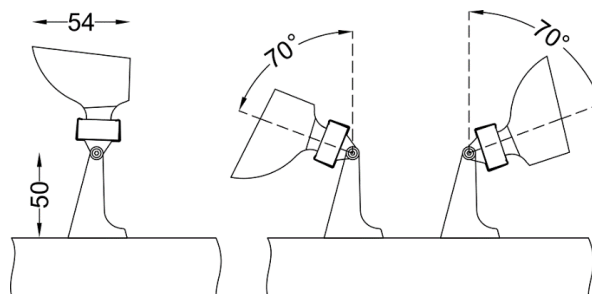

**Item:** LLL-WM-COB

**Description:** Adjustable holder for Cobra Flex Washer

### 3D Views:

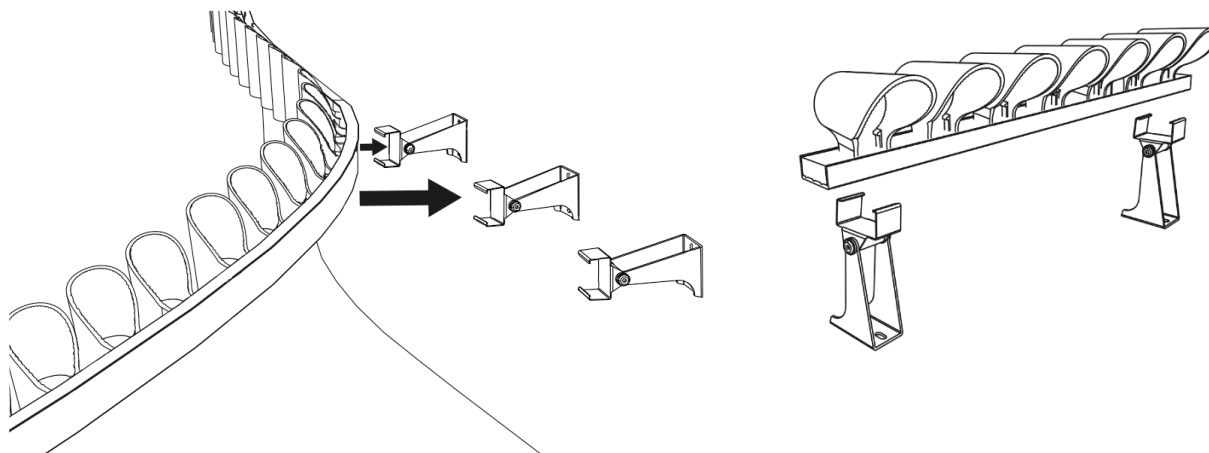

# PRODUCT SPECIFICATION

**COB Flex**

Flex Linear Static White

## Dimensions

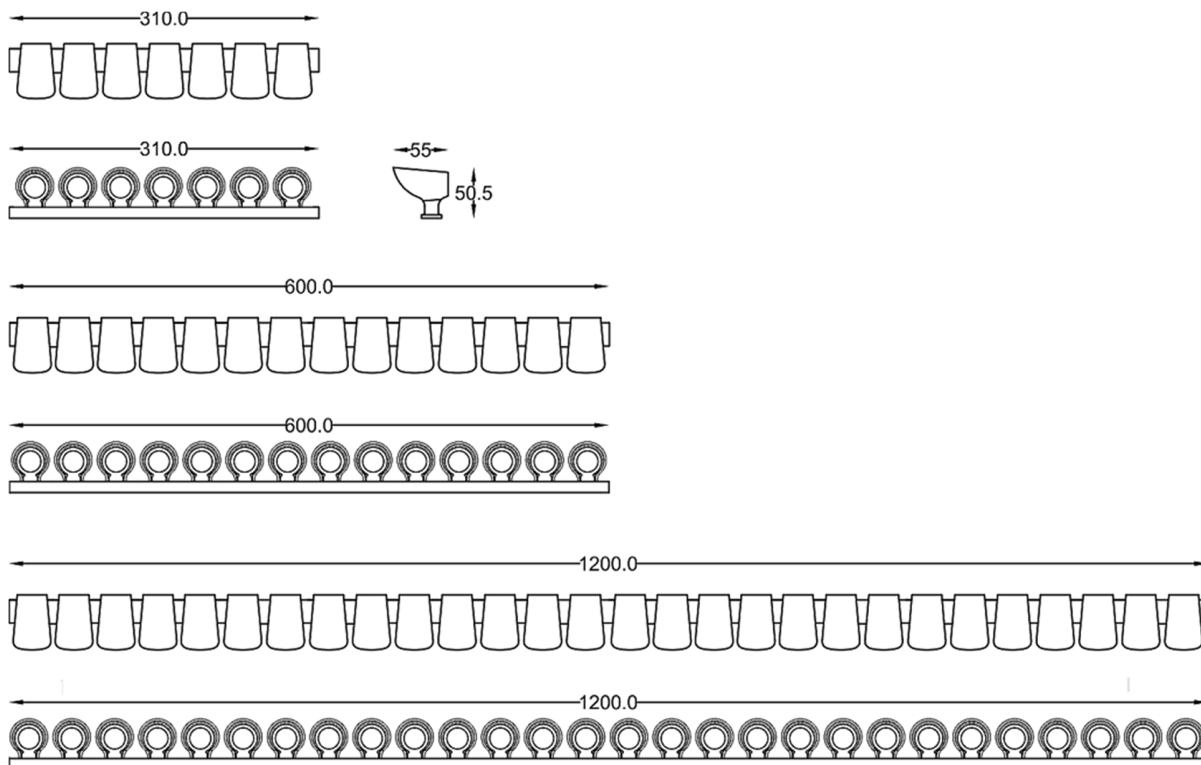

## Luminaire Order information

Example: **COB1230 . 20 – US**

1	2	3	4	5
Series	Length	CCT	Optic	Area
<b>COB:</b> Cobra Static White	<b>03:</b> 300mm <b>06:</b> 600mm <b>12:</b> 1200mm	<b>27:</b> 2700K <b>30:</b> 3000K <b>35:</b> 3500K <b>40:</b> 4000K <b>50:</b> 5000K <b>57:</b> 5700K <b>65:</b> 6500K	<b>15:</b> 15° <b>20:</b> 20° <b>30:</b> 30° <b>A1:</b> 20°x 40°	<b>EU:</b> EUROPE <b>US:</b> USA

*\*Customized optic available*

**SLS**

## Statement of Limited Warranty

### **Disclaimer of Warranty:**

Lumilime products have been tested and manufactured to the highest quality standards. The limited warranty offered by Lumilime covers defects in materials and workmanship for the period of 5 years as specified from the date of purchase (Period may be different for customized items, please consult the sales representative for final confirmation). The determination of whether the product is defective shall be made by Lumilime. Lumilime will repair or replace the defective products at no charge if a product has been determined to be defective in its materials or workmanship. Lumilime reserves the right to use similar, new, repaired, or remanufactured product or parts as part of the Limited Product Warranty process. This warranty is expressly limited to the repair or replacement of the product. The aggregate remedy for any claim shall not exceed the total amount of the purchase price for the defective product. Lumilime shall not be liable for any incidental or consequential damages in connection with or arising out of the use of the products.

### **WARRANTY PERIOD:**

The voluntary warranty lasts for 5 years for standard items and may be shorter for customized products (Please refer to "remark" in the proforma invoice). The Warranty period begins on the date of original shipment.

### **WARRANTY PROTECTION:**

2 Jahre Garantie

**SLS**

Swiss Lighting Solution

**YUVA YAPAR Erhan**

T. +41 56 249 0 100

CEO

M. +41 76 440 0 100

Badstrasse 4  
5408 Ennetbaden

info@SLS1.ch

Switzerland

e.yuva@SLS1.ch

www.SLS1.ch